

BitSquatting

BitSquatting

...or the infinite monkeys theorem...

"Three monkeys hitting keys at random on typewriters for an infinite amount of time will almost surely produce Hamlet."

-- David Ives in "Words, Words, Words"



Explanation...

Explanation...

www.twitter.com:

ASCII	t	w	i	t	t	e	r
Binary	01110100	01110111	01110100	01110100	01110100	01100101	01110010

Explanation...

www.twitter.com:

ASCII	t	w	i	t	t	e	r
Binary	01110100	01110111	01110100	01110100	01110100	01100101	01110010

www.4witter.com:

ASCII	4	w	i	t	t	e	r
Binary	00110100	01110111	01110100	01110100	01110100	01100101	01110010

Explanation...

www.twitter.com:

ASCII	t	w	i	t	t	e	r
Binary	01110100	01110111	01110100	01110100	01110100	01100101	01110010

www.4witter.com:

ASCII	4	w	i	t	t	e	r
Binary	00110100	01110111	01110100	01110100	01110100	01100101	01110010

```
~/src/code/python/bit-squat git master ./compare_characters_binary.py twitter.com 4witder.com
Domain 1 : | t | w | i | t | t | e | r | . | c | o | m |
Domain 2 : | 4 | w | i | t | d | e | r | . | c | o | m |
Difference: | 01000000 | 00000000 | 00000000 | 00000000 | 00010000 | 00000000 | 00000000 | 00000000 | 00000000 | 00000000 | 00000000 |
```

Srsly?!....

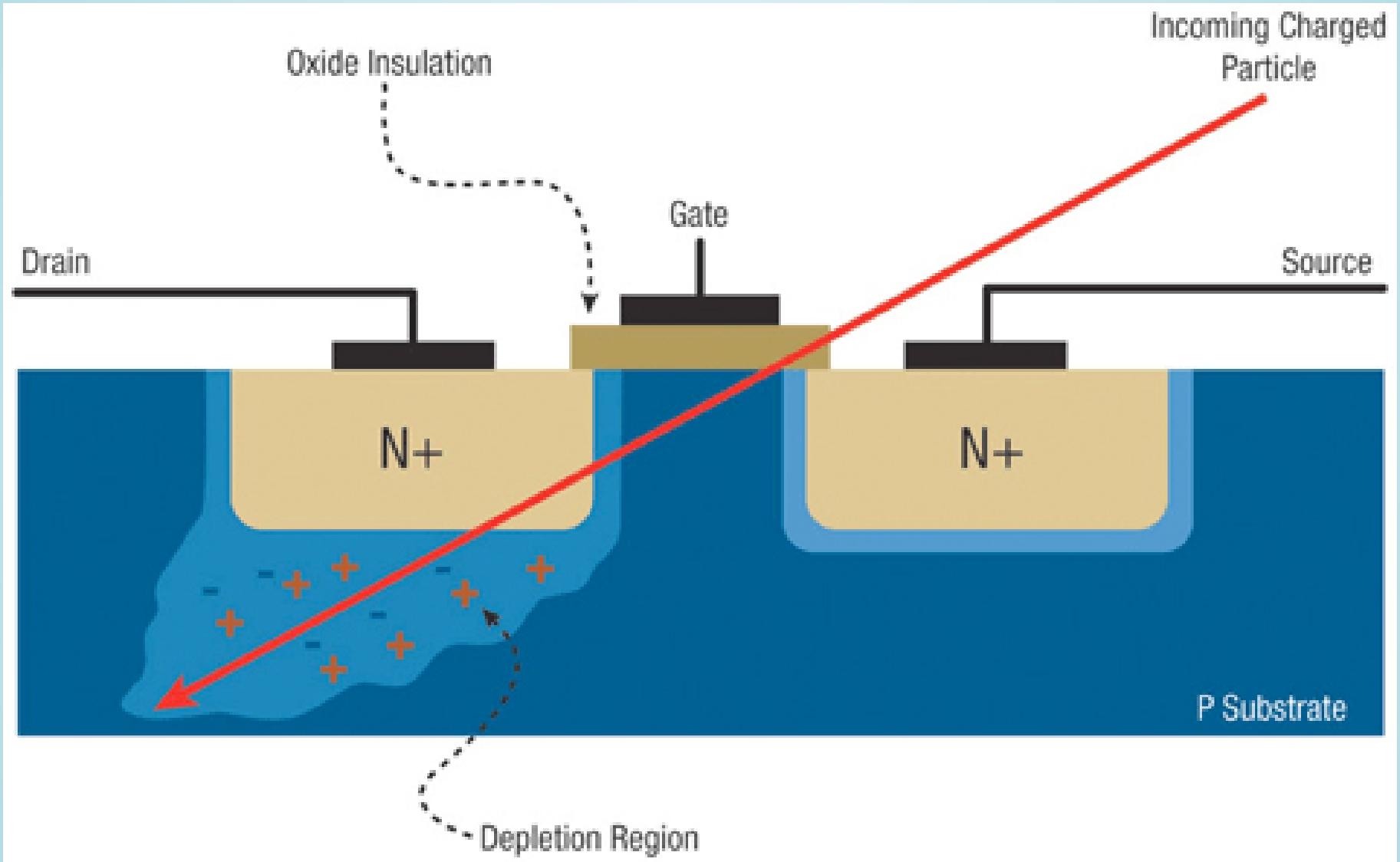

Srsly?!....

Srsly?!....

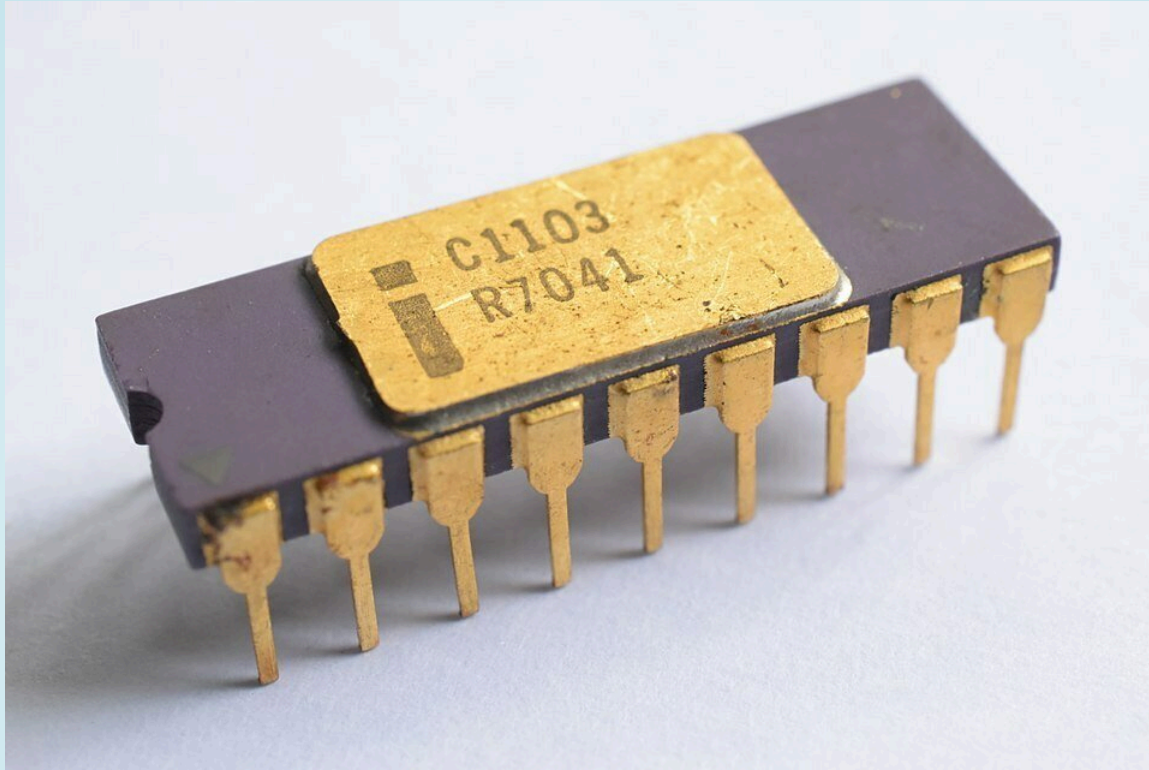

Srsly?!....

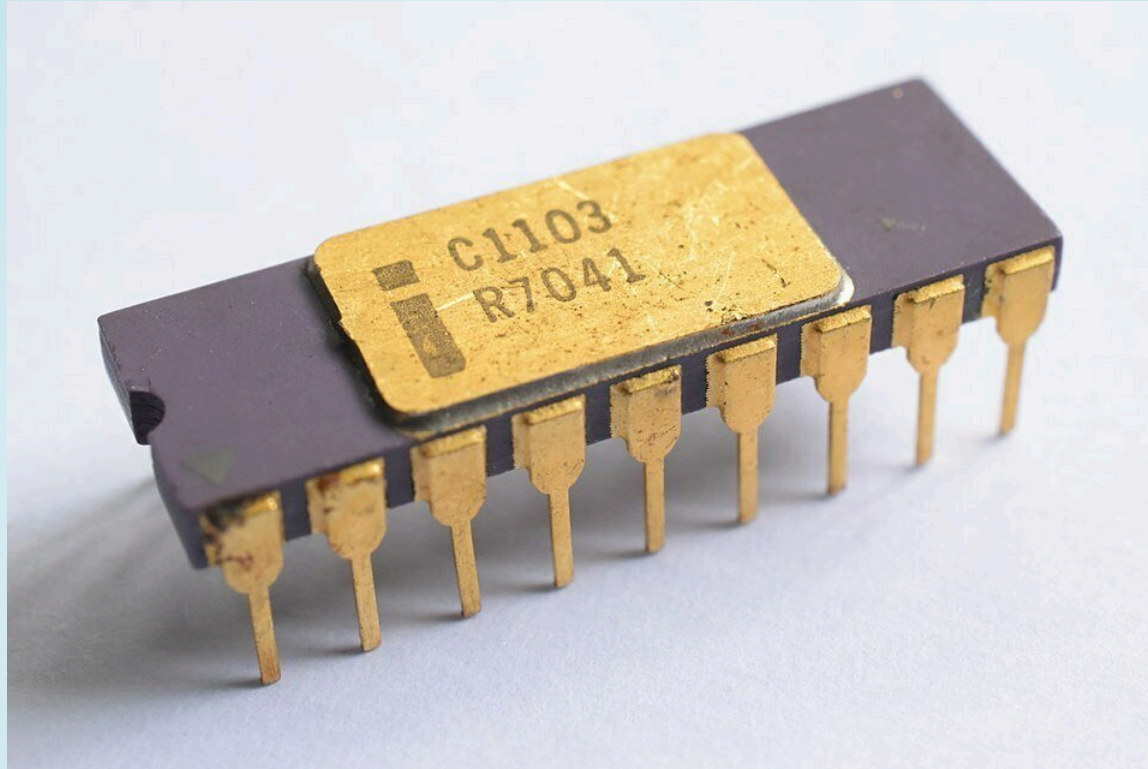

Intel 4K 2107 DRAM (~1974)

Srsly?!....

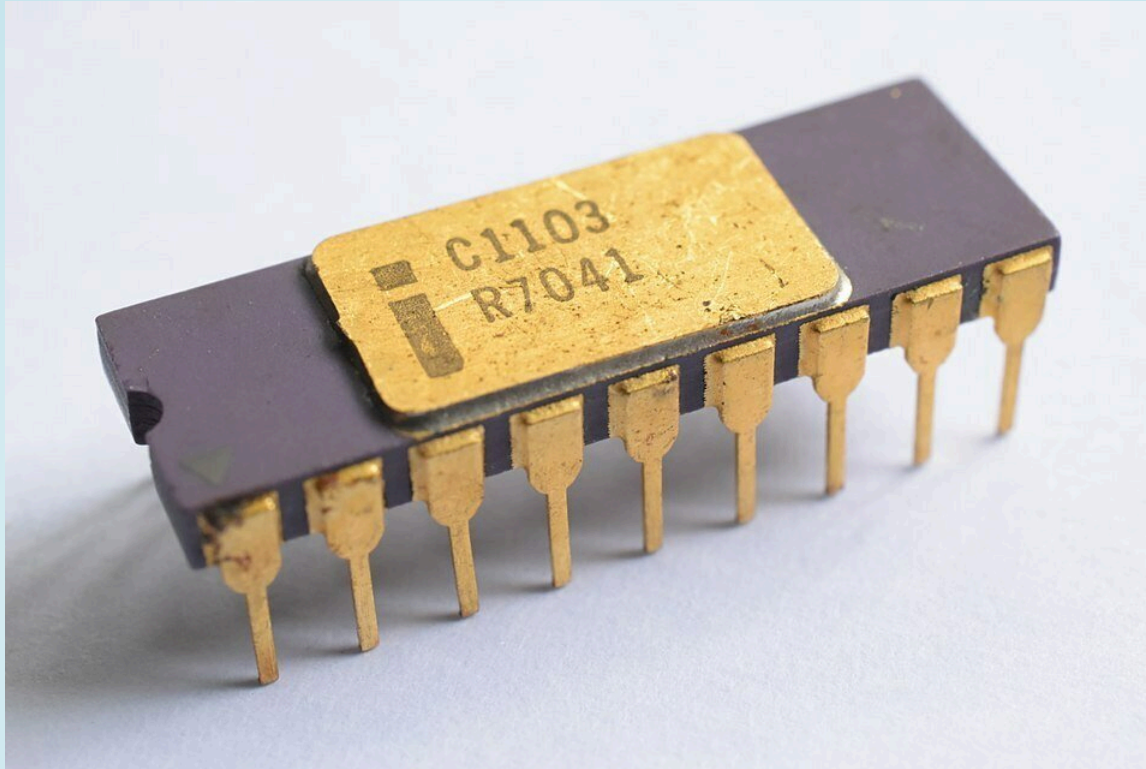

Intel 4K 2107 DRAM (~1974)

Ceramic from new factory on the Green River in Colorado...

Srsly?!....

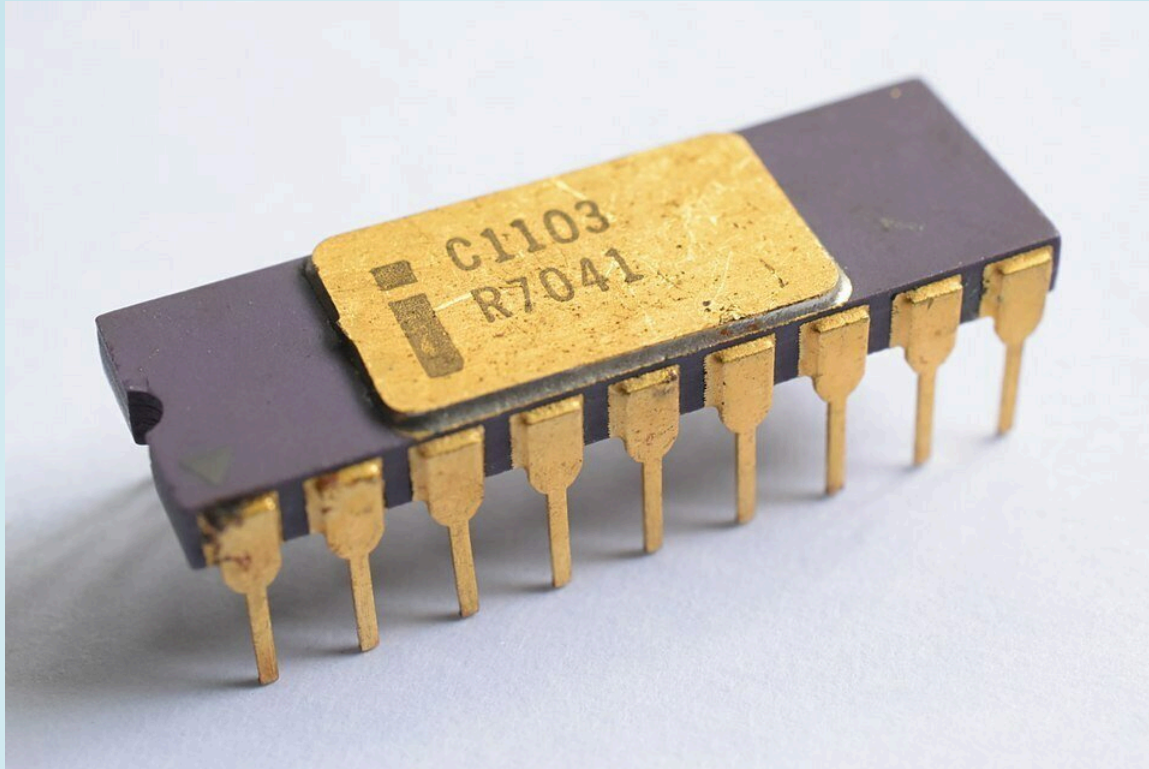

Intel 4K 2107 DRAM (~1974)

Ceramic from new factory on the Green River in Colorado...
built downstream from an old uranium mine.

Srsly?!....

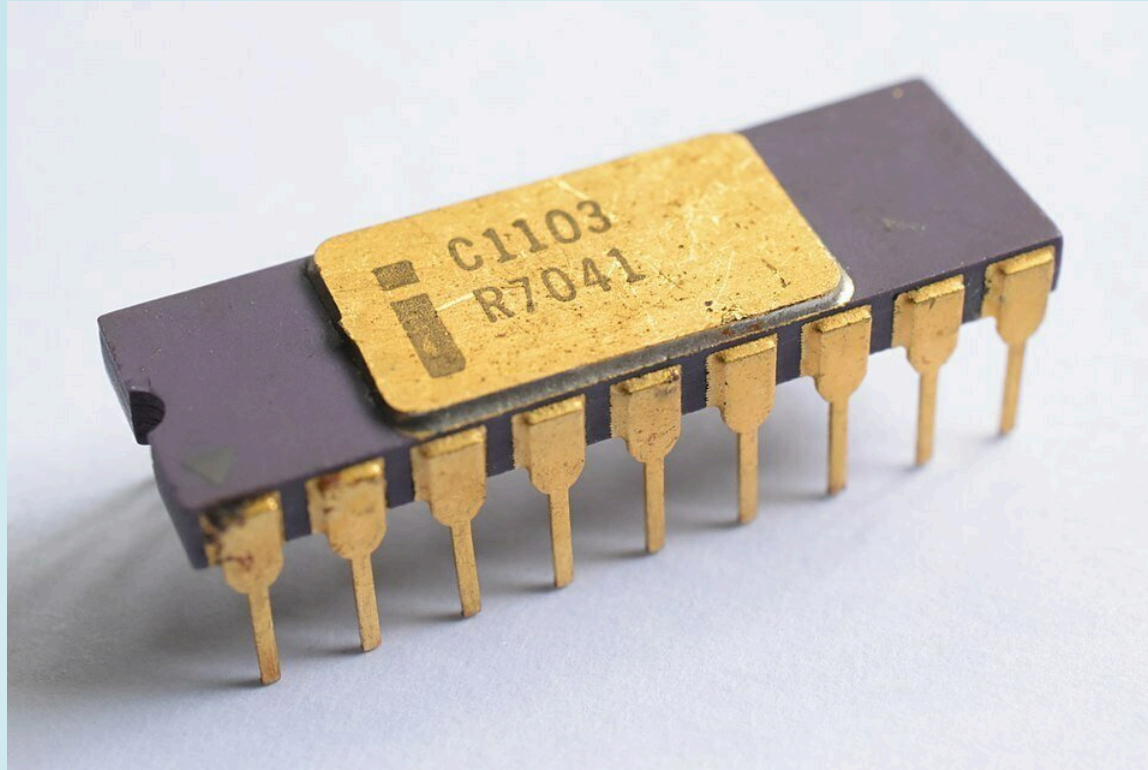

Intel 4K 2107 DRAM (~1974)

Ceramic from new factory on the Green River in Colorado...
built downstream from an old uranium mine.

Water contaminated with U238, Th232 and daughter products

Qantas Flight 72 - 7 October 2008



Qantas Flight 72 - 7 October 2008



- Flight from Singapore (SIN) -> Perth (PER) - Airbus A330-303

Qantas Flight 72 - 7 October 2008



- Flight from Singapore (SIN) -> Perth (PER) - Airbus A330-303
- Bitflip in Air Data Inertial Reference Units - Alt -> AOA
8.4 degrees pitch down and rapidly descending 200m, -0.8 g

Qantas Flight 72 - 7 October 2008



- Flight from Singapore (SIN) -> Perth (PER) - Airbus A330-303
- Bitflip in Air Data Inertial Reference Units - Alt -> AOA
8.4 degrees pitch down and rapidly descending 200m, -0.8 g
- 110 total injuries
 - 53 people hospitalized, 14 people airlifted

Doing this again...

- Original work and attention mostly 2011, I presented in 2018

BitSquat Domains

April 3, 2025 · 1 min · Warren Kumari

This is a simple page to compute the bit-squats of a domain name. A bit-squat is a domain name that is similar to another domain name but has one or more bits flipped in its binary representation. It can be used to create typosquatting domains or to find potential vulnerabilities in domain name systems.

The code below will generate a list of bit-squats for the domain name you enter. It will flip each bit in the binary representation of the domain name and display the resulting domain names.

It does not check to see if the domain name has been registered, or if the TLD exists, etc. There is a reason that it is in the toys section!

microsoft.com

Generate Bitsquats

- licrosoft.com
- oicrosoft.com
- iicrosoft.com
- eicrosoft.com
- -icrosoft.com
- mhicrosoft.com
- mkicrosoft.com
- mmicrosoft.com

Doing this again...

```
Apple ~/tmp ./compare_characters_binary.py icann.org iaann.org
Domain 1 : | i | c | a | n | n | . | o | r | g |
Domain 2 : | i | a | a | n | n | . | o | r | g |
Difference: |00000000|00000010|00000000|00000000|00000000|00000000|00000000|00000000|00000000|
```

- bankofamer**m**ca.com
- cha**q**e.com
- chas**g**.com
- cx**x**ase.com
- fb**k**dn.net
- goog**n**eapis.com
- i**a**ann.org
- i**b**ann.org
- ica**f**n.org
- ica**l**n.org
- **l**icrosoft.com
- micror**r**oft.com
- micros**m**ft.com
- micros**o**ft.com
- micros**o**nt.com
- m**m**icrosoft.com
- you**4**ube.com

Doing this again...

Setup webserver to capture:

- "Expanded names"
- SNI information
- Cookies
- URLs

Boring... these are just typos...

- Tried to choose names which are "far" on the keyboard.

Boring... these are just typos...

- Tried to choose names which are "far" on the keyboard.
- Expanded names:
 - microson**n**t.com ->
 - msedge.b.tlu.dl.delivery.mp.microson**n**t.com

Boring... these are just typos...

- Tried to choose names which are "far" on the keyboard.
- Expanded names:
 - microso`nt`.com ->
 - msedge.b.tlu.dl.delivery.mp.microso`nt`.com
- API / "System" names:
 - access-point.cloudmessaging.edge.microso`nt`.com

Boring... these are just typos...

- Tried to choose names which are "far" on the keyboard.
- Expanded names:
 - microso`n`t.com ->
 - msedge.b.tlu.dl.delivery.mp.microso`n`t.com
- API / "System" names:
 - access-point.cloudmessaging.edge.microso`n`t.com
- SNI names:
 - tlu.dl.delivery.mp.microsoft.com

Boring... these are just typos...

- Tried to choose names which are "far" on the keyboard.
- Expanded names:
 - microsoft.com ->
 - msedge.b.tlu.dl.delivery.mp.microsoft.com
- API / "System" names:
 - access-point.cloudmessaging.edge.microsoft.com
- SNI names:
 - tlu.dl.delivery.mp.microsoft.com
- Full URLs:
 - <https://dotnet.microsoft.com/en-us/download/dotnet/thank-you/runtime-desktop-6.0.12-windows-x64-installer>

Some stats... (~1 month)

Count vs. Date

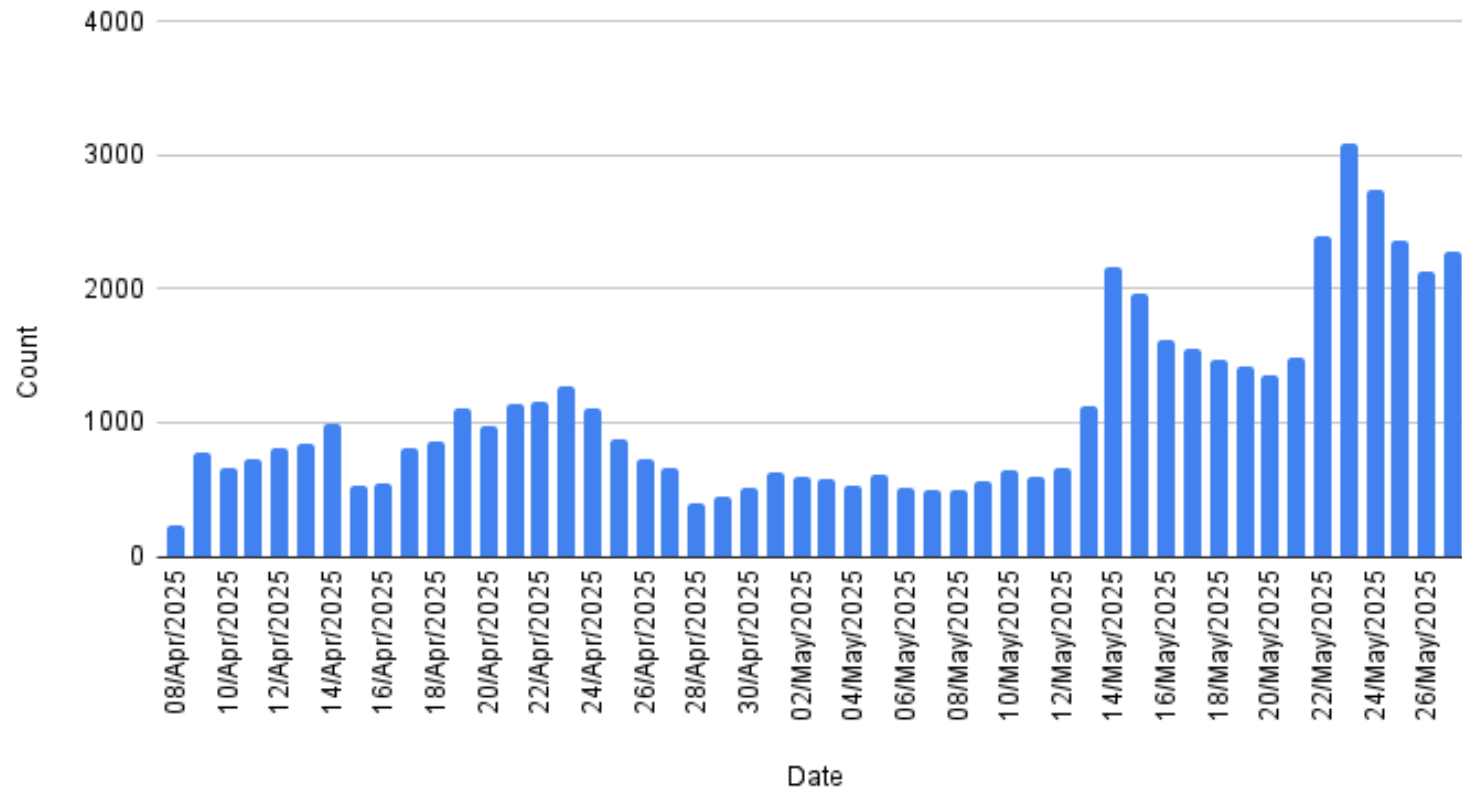

Total: 54146 - 1 month 18 days

Ignoring scrapers, cxase.com, etc.

Some stats... (1 month)

Bitflips Over Time

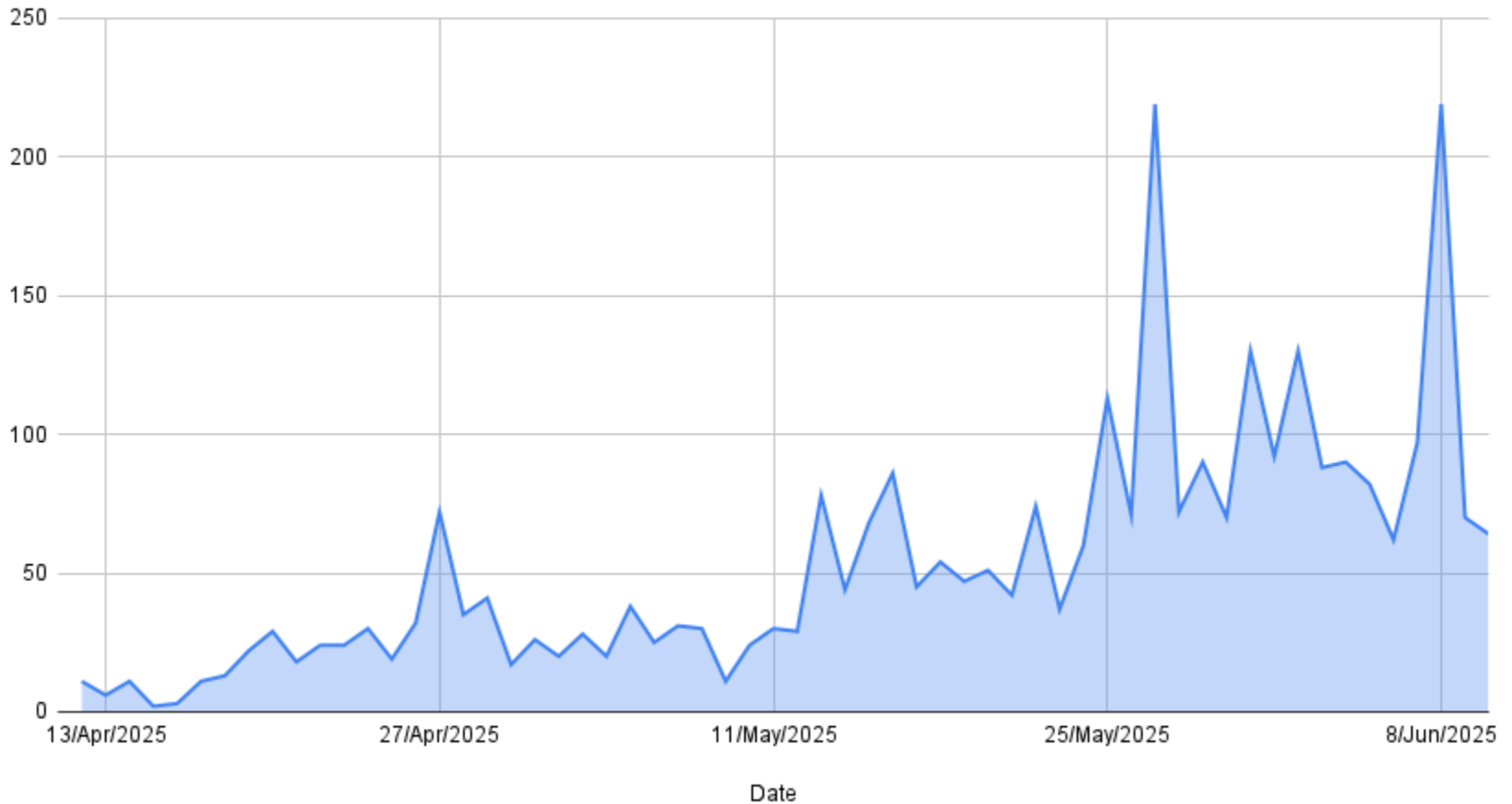

Some stats... (1 month)

Bitflips and Est Planetary K-Index

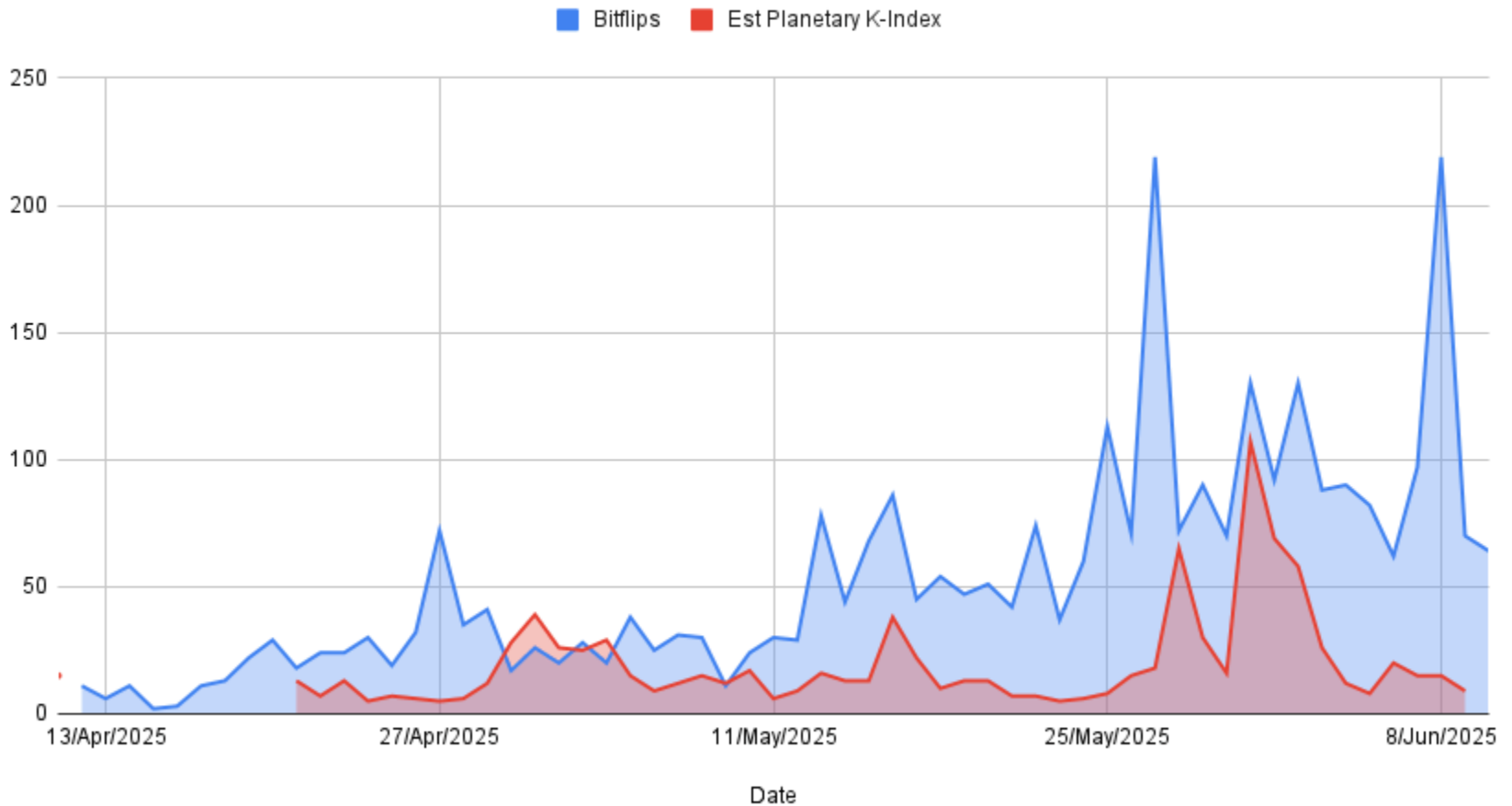

Expanded names...

(**<something>.<bitsquat>**): 487 unique

```
1073 msdn.microsoft.com
738 go.microsoft.com
727 xevbaplay.googleapis.com
719 teredo.ipv6.microsoft.com
352 self.events.data.microsoft.com
347 msedge.b.tlu.dl.delivery.mp.microsoft.com
102 internal.revenue.service.62528.cxase.com
46 bk.bankofamerica.com
42 video.fcmb11-1.fna.fbcdn.net
41 content.office.microsoft.com
39 storage.googleapis.com
39 delivery.mp.microsoft.com
37 android.googleapis.com
```

Expanded names...



SNI: 48 unique "real" domains

- `go-eu.trouter.teams.microsoft.com`
- `settings-win.data.microsoft.com`
- `video.fcmb11-1.fna.fbcdn.net`
- `geover.prod.do.dsp.mp.microsoft.com`
- `edge.microsoft.com`
- `scontent.xx.fbcdn.net`
- `mobileappcommunicator.auth.microsoft.com`
- `api-apac.flightproxy.teams.microsoft.com`
- `storage.googleapis.com`
- `geover.prod.do.dsp.mp.microsoft.com`
- `play.googleapis.com`
- `self.events.data.microsoft.com`
- `icann.org`

SNI: 48 unique "real" domains



"login" URLs

"login URLs": 23 unique. E.g:

- secure.bankofamerica.com/login/sign-in/signOnScreen.go/login.html HTTP/1.1
- [/common/oauth2/v2.0/authorize?client_id=18fbca16\[...\]](#)
- login.microsoft.com

"login" URLs



Javascript...

- <https://learn.microsoft.com/static/third-party/adobe-target/at-js/2.9.0/at.js>
- <https://wcpstatic.microsoft.com/mscc/lib/v2/wcp-consent.js>
- <https://learn.microsoft.com/static/assets/0.4.030556769/scripts/en-us/index-docs.js>
- <https://www.chaque.com/auth/fcc/js/channela.js?single>

Javascript...



Executables...

- <https://dotnet.microsoft.com/zh-cn/download/dotnet/thank-you/runtime-desktop-6.0.12-windows-x64-installer?cid=getdotnetcorp>

Executables...



Cookies!



Cookies!

```
Cookie: "PHPSESSID=gom[ELIDED]imkc3; _visitor_id=-  
OP-kQ[ELIDED]B9F-q;  
_auth_token=eyJ[ELIDED]CJ9.eyJ2a[ELIDED]Tl9.Y_SBEJG  
GCRl_HB[ELIDED]QivY;  
handl_landing_page=https%3A%2F%2Flivebh.com%2Fapart  
ments%2Fconnection-at-buffalo-  
pointe%2F%3Futm_medium%3Dredirect%26utm_campaign%3D  
vanity%26original_referrer%3Dhttps%3A%2F%2Fliveatth  
econnection.com; handl_ip=35.xxx.xxx.249;  
handl_url_base=https%3A%2F%2Flivebh.com%2Fapartment  
s%2Fconnection-at-buffalo-pointe%2F;  
handl_url=https%3A%2F%2Flivebh.com%2Fapartments%2Fc  
onnection-at-buffalo-  
pointe%2F%3Futm_medium%3Dredirect%26utm_campaign%3D  
vanity%26original_referrer%3Dhttps%3A%2F%2Fliveatth  
econnection.com utm_campaign=vanity; "
```

Cookies!

```
Cookie: "FOTOGRAF=ae17 [ELIDED] 50b;GCs=CartItem1_92_03_87_UserName1_92_4_02_;MISCGCs=USERPC1_92_201463_87_USERLL1_92_39.0438%2C77.48793_87_USERST1_92_VA3_87_LOCST1_92_VA3_87_USERDMA1_92_5113_87_DT1_92_PC;PHPSESSID=as [ELIDED] pf2;SignedIn=1;TS0133ea21=06 [ELIDED] 0250cf07cd7f08e4ee976d8f593f1ab16f10962e1eabd06f75;_auth_token=eyJhbGc [ELIDED] Xo; _visitor_id=-OP3 [ELIDED] RJz-D;dergan=09cf3f [ELIDED] 1d176937;elegantsession=1129277 [ELIDED] a6ea2adc3;handl_ip=3.xxx.xxx.5;handl_landing_page=https%3A%2F%2Fatlantaspecializedcare.com%2F; [...]"
```

Cookies!

```
$ less bitsquat_cookies_access.log | grep -v wp-log  
|grep -v x.js | grep -Ei '(token|auth)' | wc -l
```

136

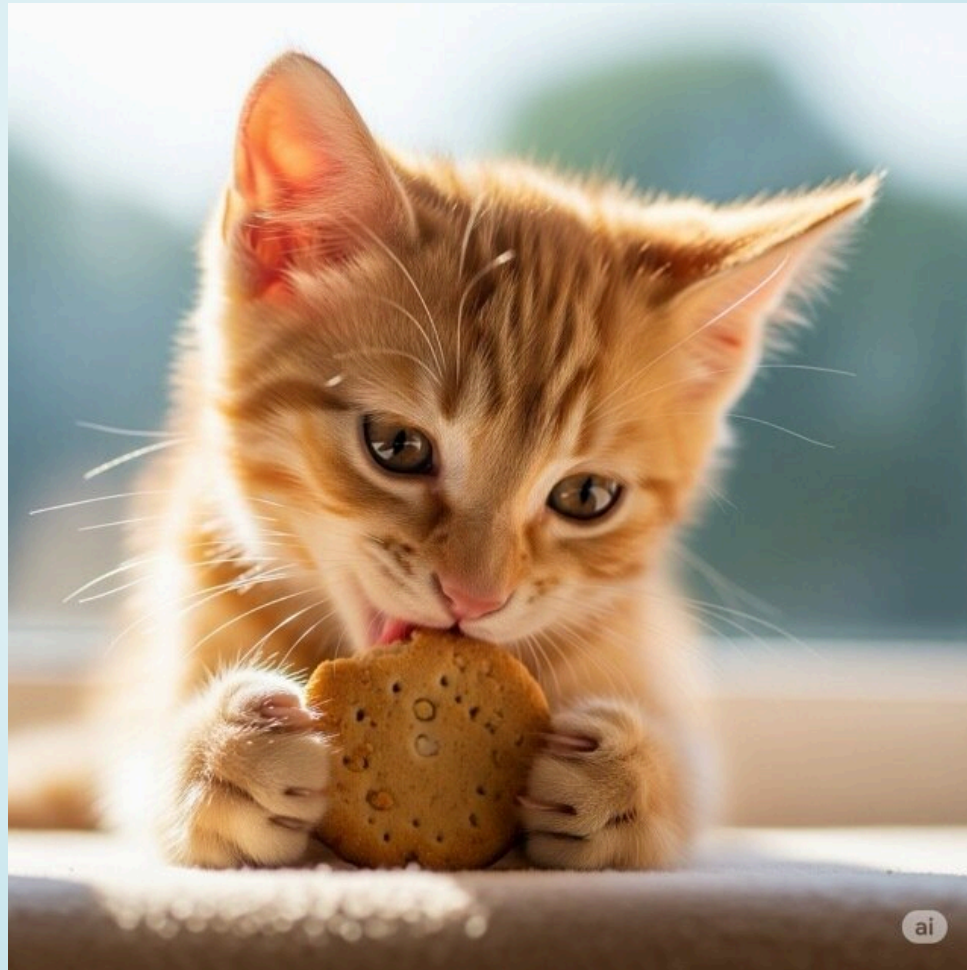

TLS will save us, right?! Right?!

TLS will save us, right?! Right?!

TLS will save us, right?! Right?!

```
127.0.0.1 - - [22/May/2025:20:58:34 +0000] "GET /  
HTTP/1.1" 200 255 "-" "-" SNI:"microsoft.com"  
Cookie:"esctx-[ELIDED]=AQ[ELIDED]AA;  
fpc=Aj[ELIDED]AA; x-ms-gateway-slice=estsfd;  
stsservicecookie=estsfd;"
```

TLS will save us, right?! Right?!

```
127.0.0.1 - - [22/May/2025:20:58:34 +0000] "GET /  
HTTP/1.1" 200 255 "-" "-" SNI:"microsoft.com"  
Cookie:"esctx-[ELIDED]=AQ[ELIDED]AA;  
fpc=Aj[ELIDED]AA; x-ms-gateway-slice=estsfd;  
stsservicecookie=estsfd;"
```

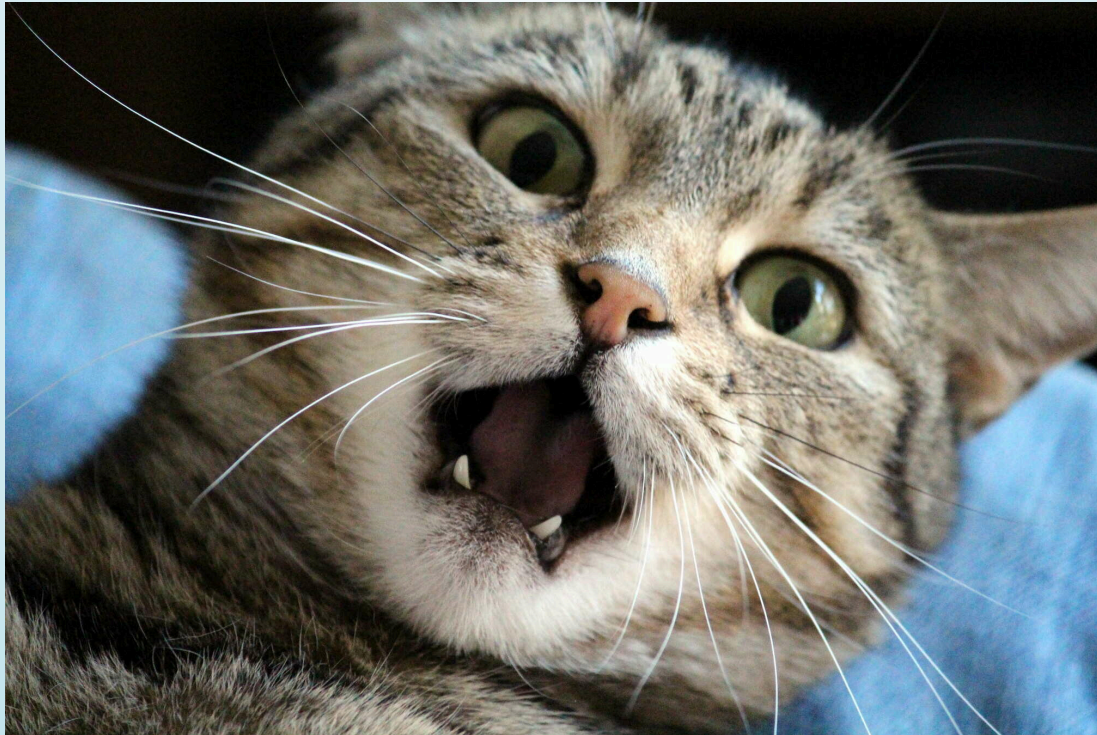



Let's prevent bitflips of TLDs!

Let's prevent bitflips of TLDs!

```
🍏 ~/src/code/python/bit-squat git master !1 ./closest_tlds.py --gtld
abb -> abc (1) 00000000|00000000|00000001|
aco -> eco (1) 00000100|00000000|00000000|
bar -> car (1) 00000001|00000000|00000000|
best -> rest (1) 00010000|00000000|00000000|00000000|
bio -> jio (1) 00001000|00000000|00000000|
bio -> rio (1) 00010000|00000000|00000000|
bms -> bmw (1) 00000000|00000000|00000100|
bom -> boo (1) 00000000|00000000|00000010|
bom -> com (1) 00000001|00000000|00000000|
boo -> foo (1) 00000100|00000000|00000000|
booking -> cooking (1) 00000001|00000000|00000000|00000000|00000000|00000000|00000000|
bot -> jot (1) 00001000|00000000|00000000|
box -> fox (1) 00000100|00000000|00000000|
cab -> car (1) 00000000|00000000|00010000|
cafe -> safe (1) 00010000|00000000|00000000|00000000|
```

Let's prevent bitflips of TLDs!

```
🍏 ~/src/code/python/bit-squat git master !1 ./closest_tlds.py --gtld
abb -> abc (1) 00000000|00000000|00000001|
aco -> eco (1) 00000100|00000000|00000000|
bar -> car (1) 00000001|00000000|00000000|
best -> rest (1) 00010000|00000000|00000000|00000000|
bio -> jio (1) 00001000|00000000|00000000|
bio -> rio (1) 00010000|00000000|00000000|
bms -> bmw (1) 00000000|00000000|00000100|
bom -> boo (1) 00000000|00000000|00000010|
bom -> com (1) 00000001|00000000|00000000|
boo -> foo (1) 00000100|00000000|00000000|
booking -> cooking (1) 00000001|00000000|00000000|00000000|00000000|00000000|00000000|
bot -> jot (1) 00001000|00000000|00000000|
box -> fox (1) 00000100|00000000|00000000|
cab -> car (1) 00000000|00000000|00010000|
cafe -> safe (1) 00010000|00000000|00000000|00000000|
```

... 60...

Let's prevent bitflips of TLDs!

```
Apple ~/src/code/python/bit-squat git master !1 ./closest_tlds.py --gtld
abb -> abc (1) 00000000|00000000|00000001|
aco -> eco (1) 00000100|00000000|00000000|
bar -> car (1) 00000001|00000000|00000000|
best -> rest (1) 00010000|00000000|00000000|00000000|
bio -> jio (1) 00001000|00000000|00000000|
bio -> rio (1) 00010000|00000000|00000000|
bms -> bmw (1) 00000000|00000000|00000100|
bom -> boo (1) 00000000|00000000|00000010|
bom -> com (1) 00000001|00000000|00000000|
boo -> foo (1) 00000100|00000000|00000000|
booking -> cooking (1) 00000001|00000000|00000000|00000000|00000000|00000000|00000000|
bot -> jot (1) 00001000|00000000|00000000|
box -> fox (1) 00000100|00000000|00000000|
cab -> car (1) 00000000|00000000|00010000|
cafe -> safe (1) 00010000|00000000|00000000|00000000|
```



... 60...

Let's prevent bitflips of TLDs!

```
🍏 ~/src/code/python/bit-squat git master !1 ./closest_tlds.py --gtld
abb -> abc (1) 00000000|00000000|00000001|
aco -> eco (1) 00000100|00000000|00000000|
bar -> car (1) 00000001|00000000|00000000|
best -> rest (1) 00010000|00000000|00000000|00000000|
bio -> jio (1) 00001000|00000000|00000000|
bio -> rio (1) 00010000|00000000|00000000|
bms -> bmw (1) 00000000|00000000|00000100|
bom -> boo (1) 00000000|00000000|00000010|
bom -> com (1) 00000001|00000000|00000000|
boo -> foo (1) 00000100|00000000|00000000|
booking -> cooking (1) 00000001|00000000|00000000|00000000|00000000|00000000|00000000|
bot -> jot (1) 00001000|00000000|00000000|
box -> fox (1) 00000100|00000000|00000000|
cab -> car (1) 00000000|00000000|00010000|
cafe -> safe (1) 00010000|00000000|00000000|00000000|
```



... 60...



Let's prevent bitflips of TLDs!

Let's prevent bitflips of TLDs!

.com -> .bom

Let's prevent bitflips of TLDs!

.com -> .bom

Thanks to NIC.br for taking this seriously...

Conclusion?!



Conclusion ?!



Questions?!



This is why we can't have nice things.

This is why we can't have nice things.

- Found lots of lookups for things like:

`http://internal.revenue.service.53093.cxase.com/department421658`

This is why we can't have nice things.

- Found lots of lookups for things like:

`http://internal.revenue.service.53093.cxase.com/department421658`

- These seemed a: scary and b: fascinating...

This is why we can't have nice things.

- Found lots of lookups for things like:

`http://internal.revenue.service.53093.cxase.com/departments421658`

- These seemed a: scary and b: fascinating...
- ... just stumbled over old phishing campaign...

This is why we can't have nice things.

- Found lots of lookups for things like:

`http://internal.revenue.service.53093.cxase.com/department421658`

- These seemed a: scary and b: fascinating...
- ... just stumbled over old phishing campaign...

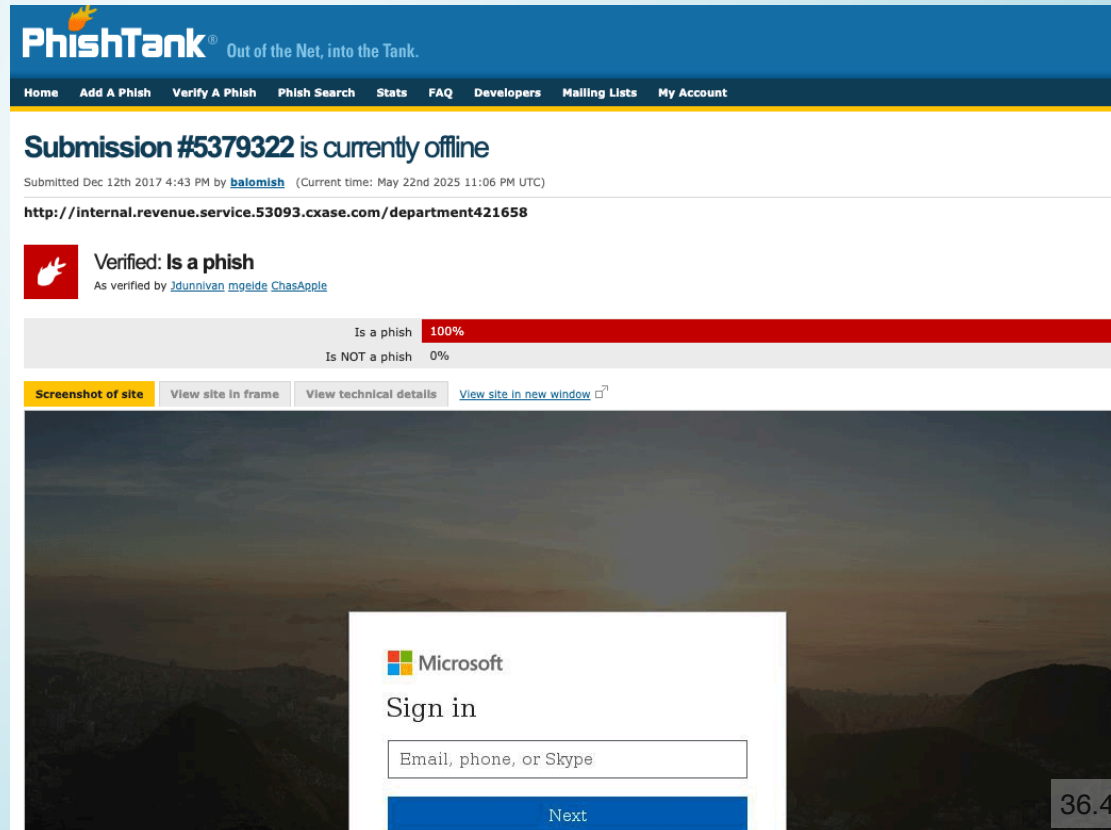

The screenshot shows the PhishTank website interface. At the top, the PhishTank logo is displayed with the tagline "Out of the Net, into the Tank." Below the logo is a navigation menu with links for Home, Add A Phish, Verify A Phish, Phish Search, Stats, FAQ, Developers, Mailing Lists, and My Account. The main content area features a heading "Submission #5379322 is currently offline" and a sub-header "Submitted Dec 12th 2017 4:43 PM by [balomish](#) (Current time: May 22nd 2025 11:06 PM UTC)". The URL `http://internal.revenue.service.53093.cxase.com/department421658` is listed. A red icon with a flame and the text "Verified: Is a phish" is shown, along with the verification source "As verified by [Jdunnivan](#) [mgeide](#) [ChasApple](#)". Below this is a progress bar showing "Is a phish 100%" and "Is NOT a phish 0%". A row of buttons includes "Screenshot of site", "View site in frame", "View technical details", and "View site in new window". The main content area displays a screenshot of a Microsoft sign-in page with the text "Microsoft Sign in" and a text input field for "Email, phone, or Skype". A blue "Next" button is visible at the bottom of the sign-in form. The page number "36.4" is located in the bottom right corner.

Moar...

- In the 2003 elections in **Brussels**'s municipality **Schaerbeek (Belgium)**, an anomalous recorded number of votes triggered an investigation that concluded an SEU was responsible for giving a candidate named **Maria Vindevoghel** 4,096 extra votes.



Maria Vindevoghel, Workers' Party of Belgium.

When it rains, it pours...

- When one bit flips, often many do.
- E.g:
 - `https://dotnet.microsoft.com/zh-cn/download/dotnet/thank-you/runtime-desktop-6.0.12-windows-x64-installer?cid=getdotnetcorp`
- was actually:
 - `dotnet.microsont.com/zn-cn/download/dotnet/tank-you/runtime-desktOD=6.0.12-windows-x64-installer?cid=getdotnetcorp`

Doesn't ECC solve this?!

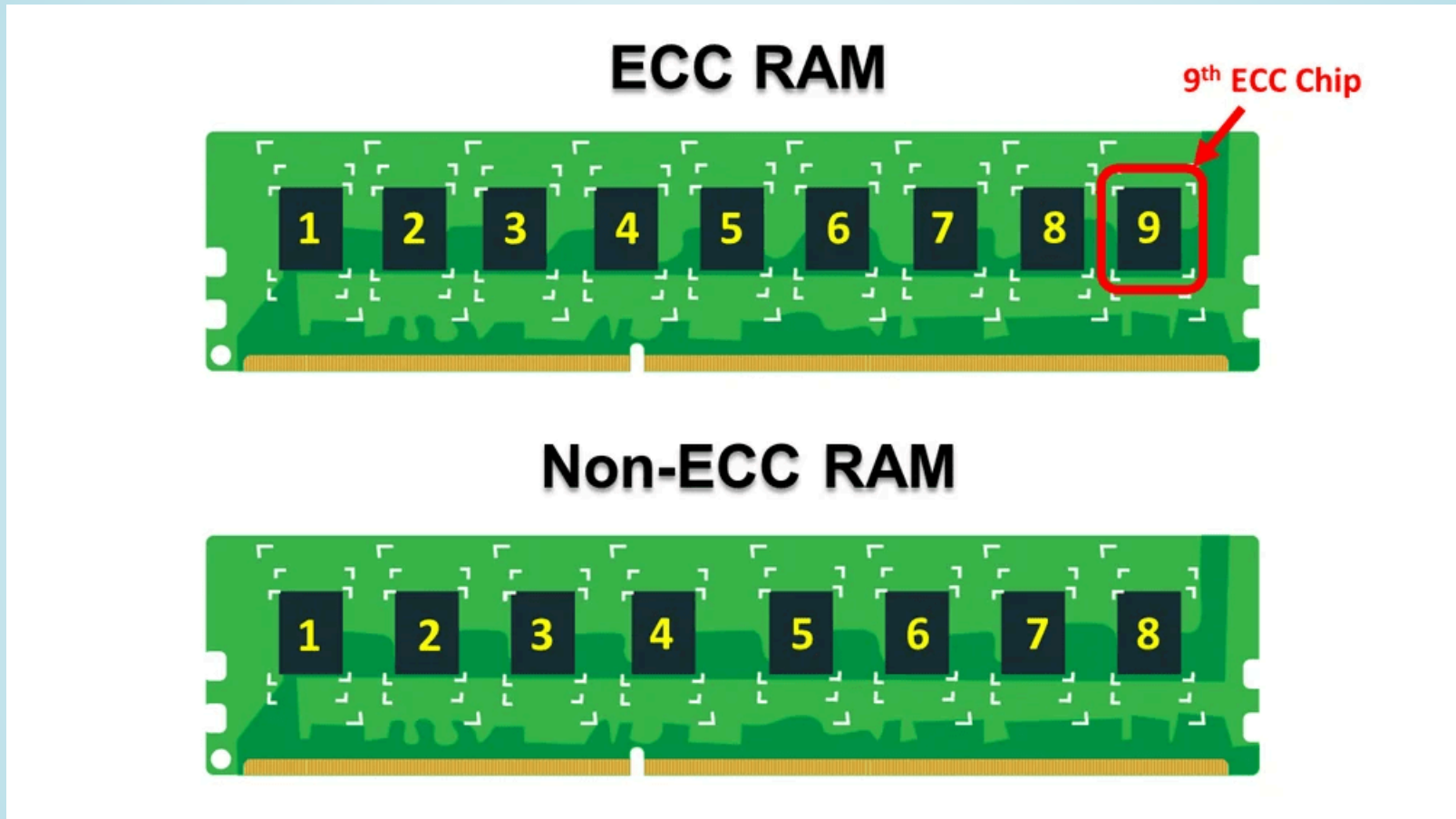

- Kinda... But ECC RAM is expensive, and is only really deployed on server type devices, not phones and laptops...

How often does this happen?!

- Soft Error Rate (SER) is measured in FIT units (failures in time). 1 FIT denotes one failure per billion device hours (114,077 years).
- SER of 1Mbit of SRAM [...], is typically in the order of 1,000 FIT for modern process technologies.
- 1GB = 8192Mbit. This is 8,192,000 FIT
- This is roughly once per 5 days!
- DRAM FIT is / was somewhat lower than SRAM, but lower voltages and cell capacitance / potential wells has made this flip

Not new...

Based on work by Artem Dinaburg

- Paper: *Bitsquatting: DNS Hijacking without Exploitation - Blackhat 2011*
- Slides: BITSQUATTING
- Video: *Defcon 19: Artem Dinaburg - Bit-squatting: DNS Hijacking Without Exploitation*

Earlier work...

Earlier work...

```
138.246.253.5 - - [13/Sep/2018:04:27:52 +0000] SNI: twitter.com "HEAD /
HTTP/1.1" 200 0 "-" "Mozilla/5.0 (Windows NT 6.1; Win64; x64)
AppleWebKit/537.36 (KHTML, like Gecko) Chrome/40.0.2214.85 Safari/537.36"
"_"

71.62.75.209 - - [13/Sep/2018:14:10:03 +0000] SNI: www.twitter.com "GET /
HTTP/1.1" 200 647 "-" "Mozilla/5.0 (Macintosh; Intel Mac OS X 10_13_6)
AppleWebKit/537.36 (KHTML, like Gecko) Chrome/69.0.3497.92 Safari/537.36"
"_"

163.172.4.153 - - [14/Sep/2018:06:31:53 +0000] SNI: - "GET / HTTP/1.1" 200
647 "http://twitter.com/" "Mozilla/5.0 (Windows NT 6.3; Win64; x64)
AppleWebKit/537.36 (KHTML, like Gecko) Chrome/56.0.2924.87 Safari/537.36"
"_"
```

Earlier work...

```
138.246.253.5 - - [13/Sep/2018:04:27:52 +0000] SNI: twitter.com "HEAD /
HTTP/1.1" 200 0 "-" "Mozilla/5.0 (Windows NT 6.1; Win64; x64)
AppleWebKit/537.36 (KHTML, like Gecko) Chrome/40.0.2214.85 Safari/537.36"
"_"
71.62.75.209 - - [13/Sep/2018:14:10:03 +0000] SNI: www.twitter.com "GET /
HTTP/1.1" 200 647 "-" "Mozilla/5.0 (Macintosh; Intel Mac OS X 10_13_6)
AppleWebKit/537.36 (KHTML, like Gecko) Chrome/69.0.3497.92 Safari/537.36"
"_"
163.172.4.153 - - [14/Sep/2018:06:31:53 +0000] SNI: - "GET / HTTP/1.1" 200
647 "http://twitter.com/" "Mozilla/5.0 (Windows NT 6.3; Win64; x64)
AppleWebKit/537.36 (KHTML, like Gecko) Chrome/56.0.2924.87 Safari/537.36"
"_"
```

```
root@ron[0]:~/tmp/tmp# grep twitter * | wc -l
102
```